



IRAM 3687 / EN 1125 COMPLIANT

INSTRUCTION MANUAL

LINE T290 / T295

This panic device manual must be provided to user

DESIGNATION PARTS

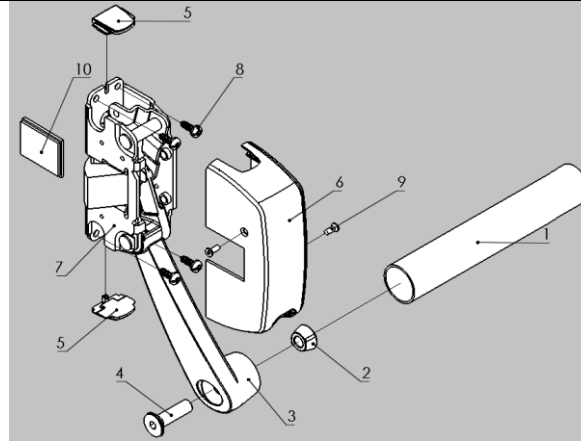

1. Bar (T005-XXX)
2. Conical nut
3. Lever arm
4. Bar screw (W5/16"x30 flat head)
5. Case plastic cover
6. Case
7. Center case
8. Center case screws (Parker n°8x1/2" round head)
9. Case screws (auto screw M3x8 flat head)
10. Latch bolt nylon cover

MECHANISM ASSEMBLY (SINGLE LEAF)

1

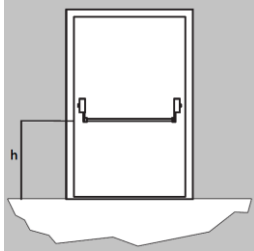

To mark mechanism height (h), mount bar at a height between 36"(900mm) and 43"(1100mm) from floor. In areas where evacuees may be mostly children, device may be installed at a lower height.

2

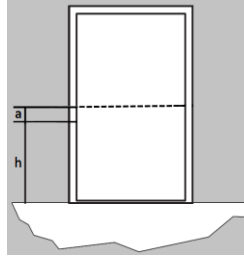

Draw a horizontal line on the door at approximately 5 1/4" (133mm) above the height before marked (h), i.e. at the height h + a.

3

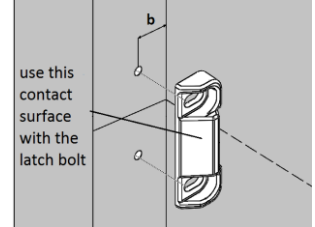

Center strike plate with line. Mount and mark holes. Drill holes on frame with a #25(3.75 mm) drill bit. The centers of the holes must be positioned at 5/8"(15 mm) 'b' distance from frame inside edge.

4

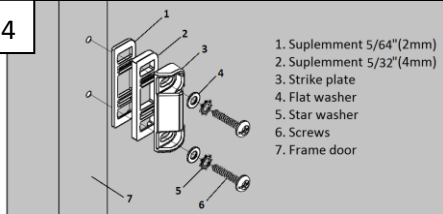

1. Suplement 5/64"(2mm)
2. Suplement 5/32"(4mm)
3. Strike plate
4. Flat washer
5. Star washer
6. Screws
7. Frame door

Secure strike plate on frame with screws and washers in the order as shown in the illustration. Mount strike plate on its support face according to step 2. Use the accessories provided, if necessary.

5

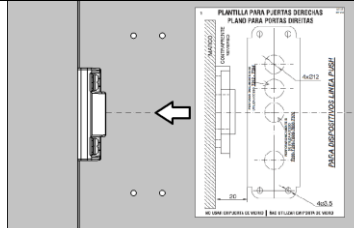

Place provided template into position and mark and drill 1/8" (3.25mm) holes on the exit device face of the door on the latch side. If outside trim is added, drill 1/2" (12mm) through holes.

6

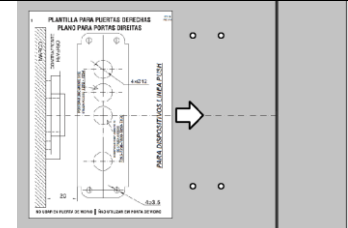

Place provided template into position and mark and drill 5/32"(3.25mm) holes on the exit device face of the door on the hinge stile. The center case must be fitted at approximately 2 3/8"(60 mm) from leaf edge.

7

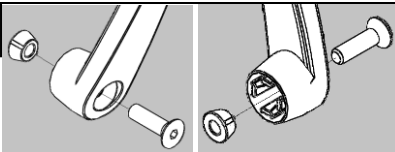

Place screw and the conical nut into the lever arm as shown above. Be sure that the nut wings stay fixed between rose flanges. Screw it manually until butted against the rose of the lever arm without securing. Follow same procedure for other lever arm.

8

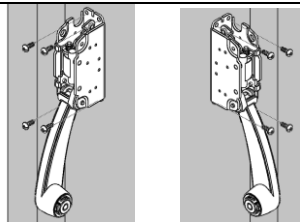

Screw arms tightly. For the lever arm on the side of the hinge, only secure two cross-head screws.

9

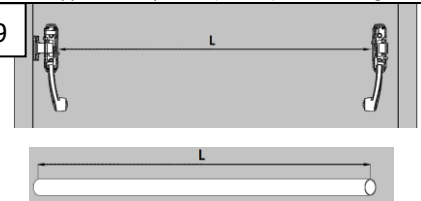

Measure length between center cases (L) and use a saw to reduce the bar length so that it can accommodate between the lever arms.

10



Mount bar on one of the arms and use a 3/16" Allen wrench to turn screw and conical nut until conical nut opens the rose of the lever arm and the bar is well adjusted. To mount bar on the second lever arm, loose one of the case screws so as to allow pivoting. Tighten second screw with its conical nut. Check bar is fitted firmly.

11

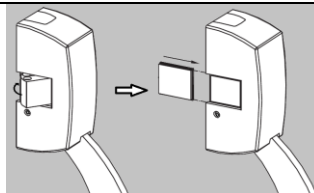

Check strike plate screws and mechanism cases are well fitted. Remember that the non-active lever arm must be blocked (on the side of the hinge). For this, insert the latch inside the center case manually and place latch cover into the case before placing the case as shown in the illustration.

12

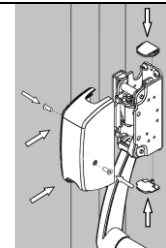

Place covers in center case as shown in the illustration. Grease cover in their hollow part. Then place cases to protect mechanisms. Use a phillips screwdriver to tighten case screws

13

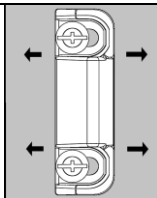

Check the smooth functioning of the door. If necessary, use strike slots to adjust the position of strike plate with closed door. The door must open smoothly.



Panic device projection category 2(3 11/16"/94mm)
 Door application field: Single and double leaf doors
 Max. Weight: 440 lbs.(200 kg.)
 Max. Width: 4' (1220mm)
 Max. Height: 8' (2440mm)
 Temperature: 14°F/140°F (-10°C / 60°C)
 Line T 295: designed for fire doors, resistance 90min.

Blincer S.R.L Calle 127 (Ombu) 1444- San Martin- Prov. Bs.As. (Argentina)
 Tel: +5411 4712 5005 web site : www.blincer.com

MANUFACTURER'S SPECIFICATIONS

"The safety features of this product comply with EN 1125 and Iram 3687. Alterations other than the ones specified in these instructions are forbidden."

REMARKS: For double leaf doors, see T291 installation instructions.

1290-88 REV.00 (10-2022)

INSTRUCTIONS PRIOR TO DEVICE INSTALLATION:

1- Before installing a panic device, make sure the door swings correctly and is unobstructed. The door design must conform with the installation requirements for this device, for example, the eccentric hinges and door latches must allow leaves to open simultaneously, the gap between leaves must be according to specification, doorway must be free of any obstruction, etc.

NOTE: The panic exit device manufactured to the above mentioned standards ensure a high safety level for the people and increased building security provided it is installed on doors and frames in good working order.

- 2- Before installing a panic device on a fire/smoke door, see door certification to make sure the door has been subjected to fire tests and is a fire/smoke rated product.
 - 3- Remove any door seal or gasket which may prevent panic device from working efficiently.
 - 4- In double doors with overlap where panic devices are installed on both leaves, please make sure that each leaf opens when its panic device is pressed and that both leaves open correctly when both panic devices are pressed simultaneously. For this application, a device for increased opening may be required to activate main door leaf.
 - 5- If the lengths of panic exit devices are different, please adjust length for this application.
 - 6- Grade 2 panic exit devices (standard exit) must be used when the space for door opening is narrow or door cannot open more than 90°.
 - 7- Doors and frames must be firm enough so as to hinder any distortion greater than 3/16" (5 mm) in any position while in use.
 - 8- If a device is installed on a glass panel door, make sure the glass is tempered or laminated.
 - 9- If panic device is installed on an emergency exit door made of wood, metal or glass without any frame, you may need to use a different fitting system. For a safer fitting, use male or female through bolts.
 - 10- The material of the leaf door where device is installed must be resistant to a tensile force greater than 1.5 KN applied to each screw.
 - 11- Panic exit devices are not designed for double acting traffic doors.
 - 12- Follow installation instructions carefully. Installer must hand over Installation and Maintenance Instructions to the user.
 - 13- The length of push bar must be its maximum possible length, which cannot be lower than 60% of the door width.
 - 14- Install latches and strike plates in a way to ensure a safe locking. It is important that the latch projection -when in retraction- does not prevent door swinging freely.
 - 15- If the device is installed on double leaf doors with overlap and automatic closing device, we recommend the use of a door coordinator under EN 1158 to ensure a reliable sequential closing. This recommendation is particularly important in case of fire and/or smoke doors.
 - 16- For the door lock in closed position, do not use devices other than those specified in the European standard EN 1125 and IRAM 3687. This standard does not rule out the installation of automatic closing systems.
 - 17- If a door closing system is used to return door to closed position, be careful not to block escape exit route for children, elder and disabled people.
 - 18- Any lock plate, receptacle or protection plate for panic devices must be installed in compliance with EN 1125 and IRAM 3687.
- We recommend the use of a sign which reads 'push bar to open' or a pictogram placed on the inside face of the door above the push bar or on the bar itself if there is enough room for pictogram. The pictogram surface must be not smaller than 12 7/16 in²(8000 mm²) and pictures must be white in a green background; the arrow must indicate the door operation when installed.

PRODUCT COMPATIBILITY:

T290 Bars T005-XXX (obligatory); Vertical locking (optional) T291-00/00B/00G/04/04B; Vertical locking rods (optional) T291-01/05;

Outside trims (optional): T800-XXX / T850-XXX / T870-XXX

T295 Bars T005-XXX (obligatory); Vertical locking (optional) T291-06/07; Vertical locking rods (optional) T291-01/05;

Outside trims (optional): T800-XX X/ T850-XXX / T870-XXX

Remarks: In case of double doors, the use of vertical locking and vertical locking rods on the secondary door leaf is obligatory.

Important: The panic exit device (T295) suitable for fire resistant doors must be placed on a door that is also fire resistant and approved at a time equal to or less than that of the device.

CLASIFICACION UNDER UNE-EN 1125:

T290:

3	7	6	0	1	3	2	2	A	A
---	---	---	---	---	---	---	---	---	---

MAINTENANCE INSTRUCTIONS:

In order to comply with EN 1125 and IRAM 3687, it is important to carry out routine maintenance works on a monthly basis or at least every 20 000 opening cycles.

- a) Check and operate the panic device to ensure that all parts are in good working order.
- b) Ensure that the lock(s) is/are unobstructed.
- c) Make sure that the contact surfaces between the latch and strike plate are lubricated with lithium grease at a use temperature suitable for the use conditions (for example: Special grease GR 2/3 DILMAX or of a similar kind). Check panic device and its accessories, if suitable.
- d) Check no other locking devices have been added to the door since panic device was first installed.
- e) At regular intervals check all the system parts are genuine and certificate-compliant.
- f) The fit of the door must be regularly monitored and with the use of a force meter measure and record opening and closing forces to release panic device. Check opening and closing forces have not greatly changed since they were first recorded when installing device.